

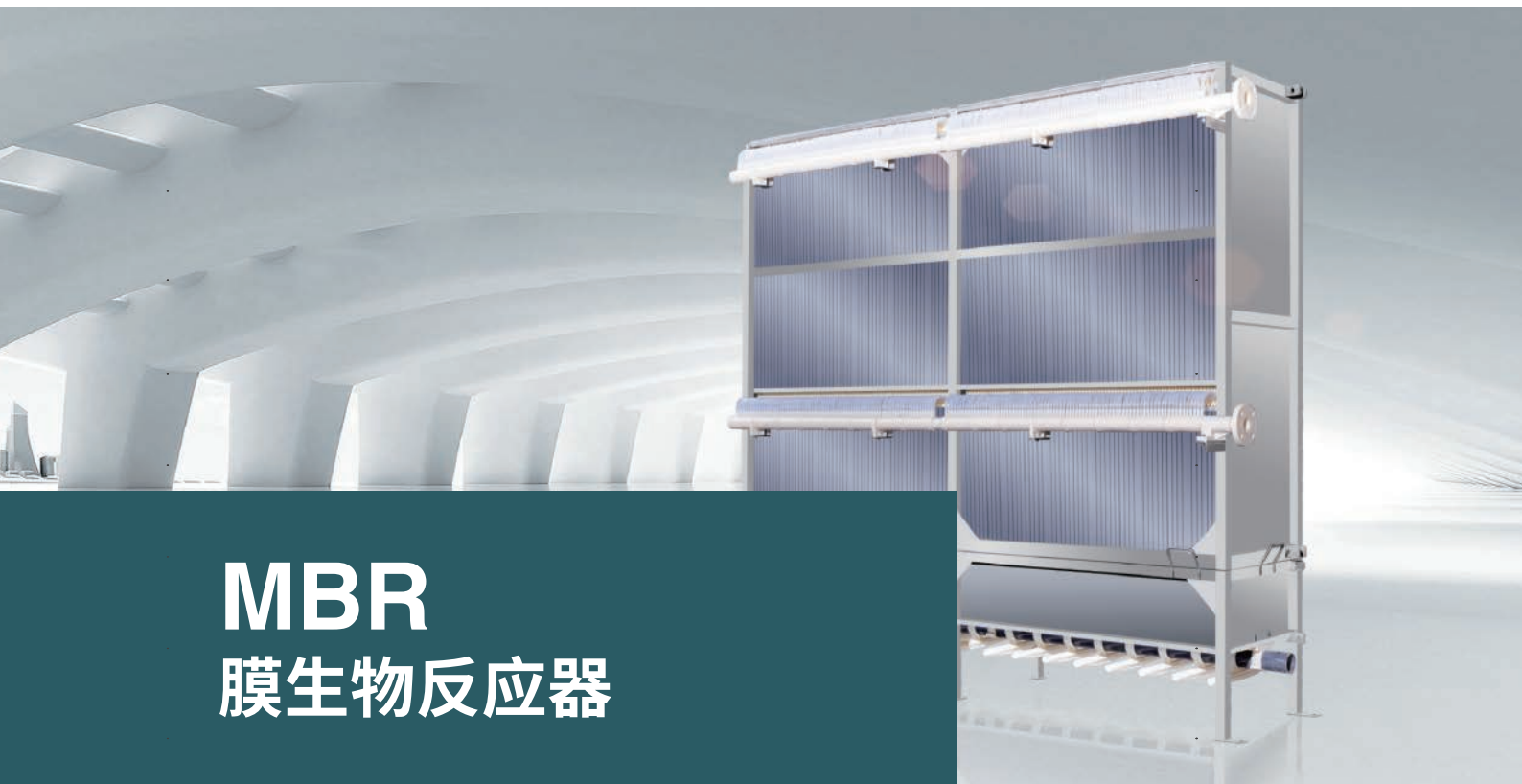

川源(中国)机械有限公司
GSD (China) Co., Ltd.



MBR 膜生物反应器

MBR Membrane Bioreactor

膜生物反应器

Membrane Bioreactor

简介 Introduction

膜生物反应器 (MBR: Membrane Bioreactor) 是一种将高效膜分离技术与传统活性污泥法相结合的新型高效污水处理工艺。它用膜组件代替传统活性污泥法中的二沉池, 截留生物系统的微生物菌群, 促使系统微生物菌群数量和种类聚增, 提高了污水处理能力和效率, 从而大幅度改善了系统出水水质。

MBR 的核心部件是高性能的浸没式平板膜组件, 采用负压抽吸式过滤, 运行能耗比采用加压过滤的分置式膜组件减少了 10 ~ 20 倍; 平板膜组件结构简单, 运行时在曝气气流与污水水流混合冲刷下, 膜表面不易堆积污泥, 从而确保 MBR 系统能够长期稳定运行。

Membrane Bioreactor (MBR) is a new type of high-efficiency wastewater treatment process that combines high-efficiency membrane separation technology with the traditional activated sludge process. The secondary sedimentation tank in the traditional activated sludge process is replaced with membrane modules to intercept the microbial flora of the biological system, promote the accumulation and increase of the number and species of the system microbial flora, and increase the wastewater treatment capacity and efficiency, thereby improving the quality of system effluent significantly.

The core component of MBR is a high-performance submerged flat-sheet membrane module, which applies negative pressure suction filtration, with operating energy consumption 10-20 times less than that of a separate membrane module that uses pressure filtration. The flat-sheet membrane module is simple in structure and not prone to accumulating sludge on the surface under the mixed scouring of aeration airflow and sewage flow, thereby ensuring the long-term stable operation of the MBR system.

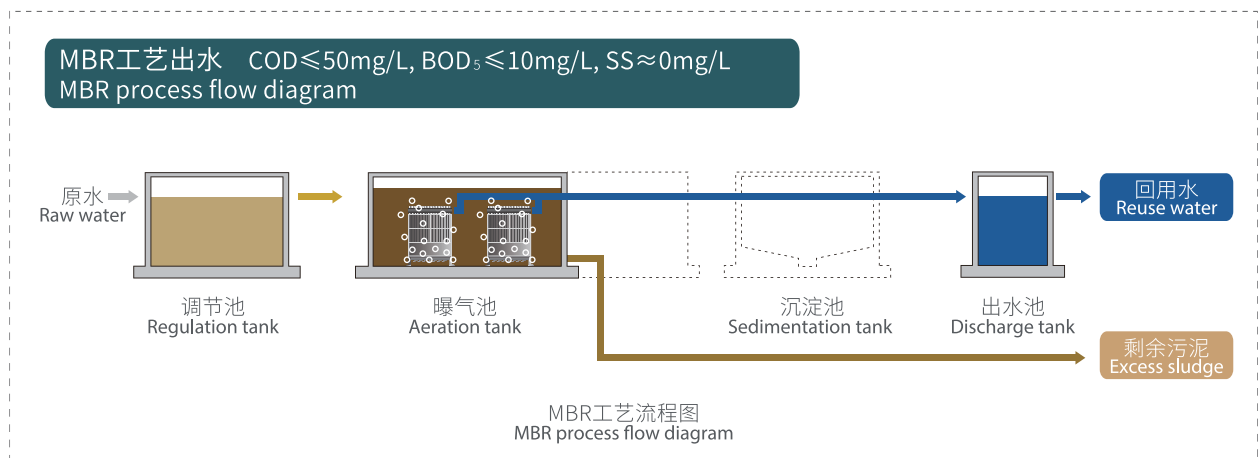
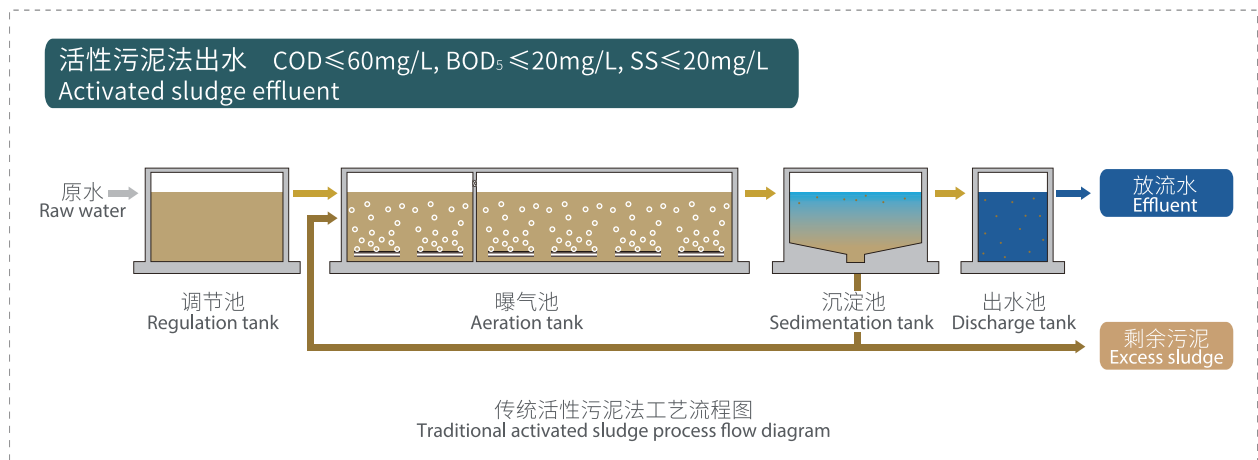

MBR工艺优势 MBR Process Advantages

■ 占地面积小

在 MBR 工艺中，活性污泥浓度一般控制在 6000 至 12000mg/L，这相当于传统活性污泥系统的 2 ~ 3 倍。因此，MBR 工艺的生化处理效率得到极大提高，反应池占地面积可节约 30%。另外，膜组件可代替澄清和过滤等深度处理工艺，达到中水回用水质要求，因此节约了整个污水处理厂升级改造的占地面积。

■ 良好的产水水质

一般来说，经过 MBR 工艺处理的污水几乎检测不到悬浮物，浊度通常小于 1NTU。结合了膜分离技术的生化处理工艺，MBR 产水几乎可以应用于所有非饮用型回用领域—农业绿化灌溉、锅炉补给水 (RO 预处理) 和工业工艺给水等。同时 MBR 工艺可以有效减少病原性细菌的存在，例如大肠杆菌和隐孢子虫。

■ 易于操作、运行稳定

通过代替二沉池、澄清池或过滤池等处理单元，MBR 可集成为一体化工艺运行。因为取消了受污泥浓度和性状影响较大的沉淀池，以及常规深度处理需要的化学药剂 (如混凝剂和絮凝剂) 投加系统，相比传统活性污泥法减少了工作量，并可通过现场及远程自动控制，实现长期稳定运行。

■ Small footprint

In the MBR process, the concentration of activated sludge is generally controlled at 6,000–12,000 mg/L, equivalent to 2–3 times that of the traditional activated sludge system. Hence, the biochemical treatment efficiency of the MBR process is significantly improved, and the floor space of the reaction tank can be saved by 30%. Moreover, membrane modules can replace advanced treatment processes such as clarification and filtration to meet the quality requirements for reclaimed water reuse, thereby saving the area of the whole sewage treatment plant in upgrade and transformation.

■ Good effluent quality

Generally speaking, suspended solids can hardly be detected in the wastewater treated by MBR process, and the turbidity is usually less than 1 NTU. Combined with the biochemical treatment process of membrane separation technology (MST), MBR effluent can be used in almost all non-potable reuse fields such as green agricultural irrigation, boiler feed water (RO pretreatment), and industrial process water supply. Meanwhile, the MBR process can effectively reduce the presence of pathogenic bacteria, such as Escherichia coli and Cryptosporidium.

■ Easy to operate and stable in operation

By replacing the processing units such as the secondary sedimentation tank, clarification tank, or filtration tanks, an integrated MBR process can be operated. Due to the elimination of sedimentation tank, which is greatly affected by the concentration and properties of sludge, and chemical agents (such as coagulant and flocculant) dosing system required for advanced conventional treatment, the workload is reduced compared with the traditional activated sludge process. Moreover, on-site and remote automatic control can be implemented to achieve long-term stable operation.

MBR平板膜元件

MBR Flat-sheet Membrane Unit

简介 Introduction

MBR 平板膜元件主要由支撑板、导流布、滤膜三部分组成，平板滤膜通过超声波或热熔焊被固定在 ABS 支撑板的两面上，在抽吸负压的作用下，产水经过滤膜从出水口处被抽出，活性污泥被拦截在 MBR 池内。

The MBR flat-sheet membrane unit is mainly composed of three parts (support plate, diversion cloth, and filter membrane). The flat-sheet filter membrane is fixed on both sides of the ABS support plate by ultrasonic/thermal welding. The effluent is drawn out from the water outlet through the filter membrane, and the activated sludge is intercepted in the MBR tank.

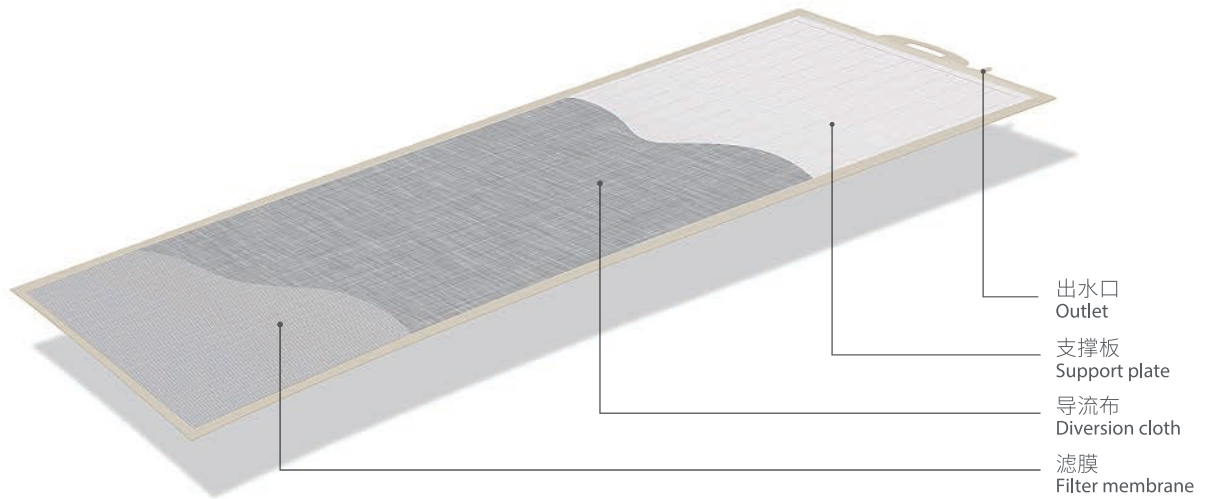

平板膜元件构造图
Flat-sheet membrane unit structure diagram

膜元件型号说明 Membrane unit Model Description

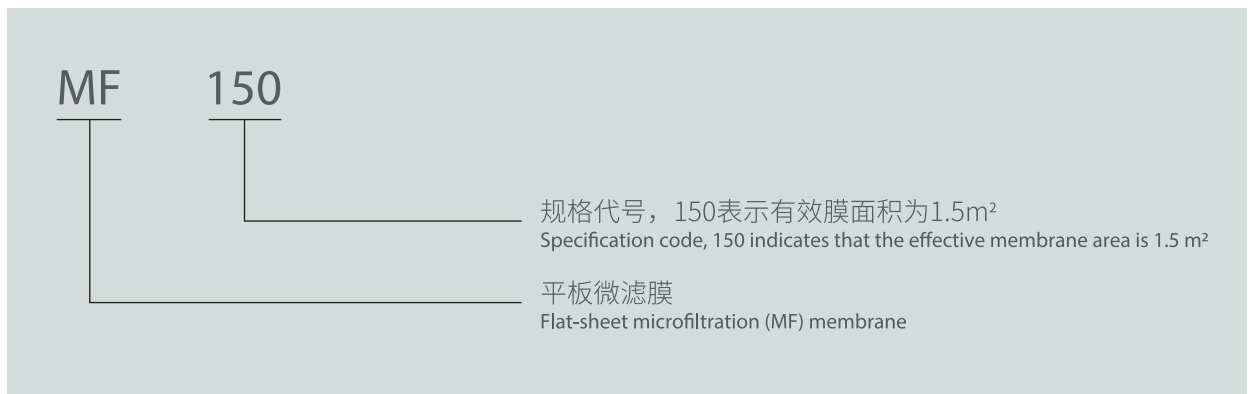

膜元件出水方式 Membrane unit Effluent Mode

膜元件分为单出水口，双出水口两种形式，根据有效膜面积的大小，单出水口膜元件有0.8m²、1.0m²二种型号，双出水口膜元件仅有1.5m²一种型号。

Membrane units include two forms: single outlet and double outlet. Based on the effective membrane area, single outlet membrane units have two models (0.8 m² and 1.0 m²); double outlet membrane units have only one model (1.5 m²).



单出水口膜元件
Single outlet membrane unit

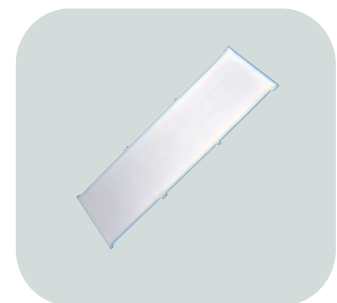

双出水口膜元件
Double outlet membrane unit

膜元件型号表 Membrane Unit Specifications

型号 Model		MF80	MF100	MF150
有效膜面积 (m ²) Effective membrane area (m ²)		0.8	1.0	1.5
尺寸 (长×宽×高) Dimensions (mm) (length×width×height)		1030×490×7.5	1190×518×7.5	1750×510×7.5
产水量 (L/片·天) Flux (L/piece·d)		320~480	400~600	690~1035
材料组成 Material composition	滤膜+导流布 Filter membrane + diversion cloth	PVDF+PET		
	膜孔径 (μm) Membrane pore size (μm)	0.1		
	支撑板 Support plate	ABS		
曝气量 (L/min·天) Aeration rate (L/min·d)		10	11	12
重量 (kg) Weight (kg)		3.2	3.6	5.8
出水浊度 (NTU) Effluent turbidity (NTU)		≤1		
出水悬浮物 (mg/l) Effluent suspended solids (mg/l)		≤5		

注： 1.上表中的产水量均指清水测试值、抽吸负压为-10kPa、水温为25℃时膜的初始过滤通量；对不同的水质，其产水量会有较大差别。
2.市政污水及类似性质污水建议设计通量为400-500L/m²·d，工业污水设计通量与污水性质有关，具体请咨询我司设计人员。
3.MF80、MF100膜元件为单出水口，MF150膜元件为双出水口。

Note: 1. The Flux in the above table refers to the initial filtration flux (test value of clean water) of the membrane at a negative suction pressure of -10 kPa and water temperature of 25°C, which may differ significantly for different water quality.
2. The recommended design flux of municipal sewage and wastewater of similar nature is 400~500 L/m²·d. The design flux of industrial sewage is related to the nature of the sewage. Please consult our designers for details.
3. MF80 and MF100 membrane units are single outlets, and MF150 membrane units are double outlets.

膜元件使用环境

- pH 值：6~9
- 悬浮物(SS)：≤200mg/L
- 工作温度：10℃~40℃
- 颗粒大小：≤2mm
- 矿物油：≤5mg/L
- 动植物油：≤20mg/L
- 尖锐固体物质：0
- BOD₅/COD：≥0.3
- 硬度：≤350mg/L

Membrane unit application environment

- pH: 6~9
- Suspended solids (SS): ≤200mg/L
- Working temperature: 10°C~40°C
- Particle size: ≤2mm
- Mineral oil: ≤5mg/L
- Animal and vegetable oils: ≤20 mg/L
- Sharp solid matter: 0
- BOD₅/COD: ≥0.3
- Hardness: ≤350 mg/L

设备开启前，请确认膜池水质是否达到以上指标标准，如不具备，请调试至满足标准水质之后再开启或咨询我司技术人员。

Before turning on the equipment, please confirm whether the water quality of the membrane tank complies with the above index standards. If not, please adjust until it meets the standard water quality before turning on the equipment or you may contact our technician for advice.

MBR平板膜组件

MBR Flat-sheet Membrane Module

MBR 平板膜组件包含膜箱、曝气底座及其配件。膜箱装有一定数量的按一定间隔装填的膜元件，曝气底座包含主曝气管及分曝气管。

The MBR flat-sheet membrane module includes a membrane case, aeration case and accessories. The membrane case is equipped with a certain number of membrane units packed at certain intervals, and the aeration case includes main aeration pipe and branch aeration pipes.

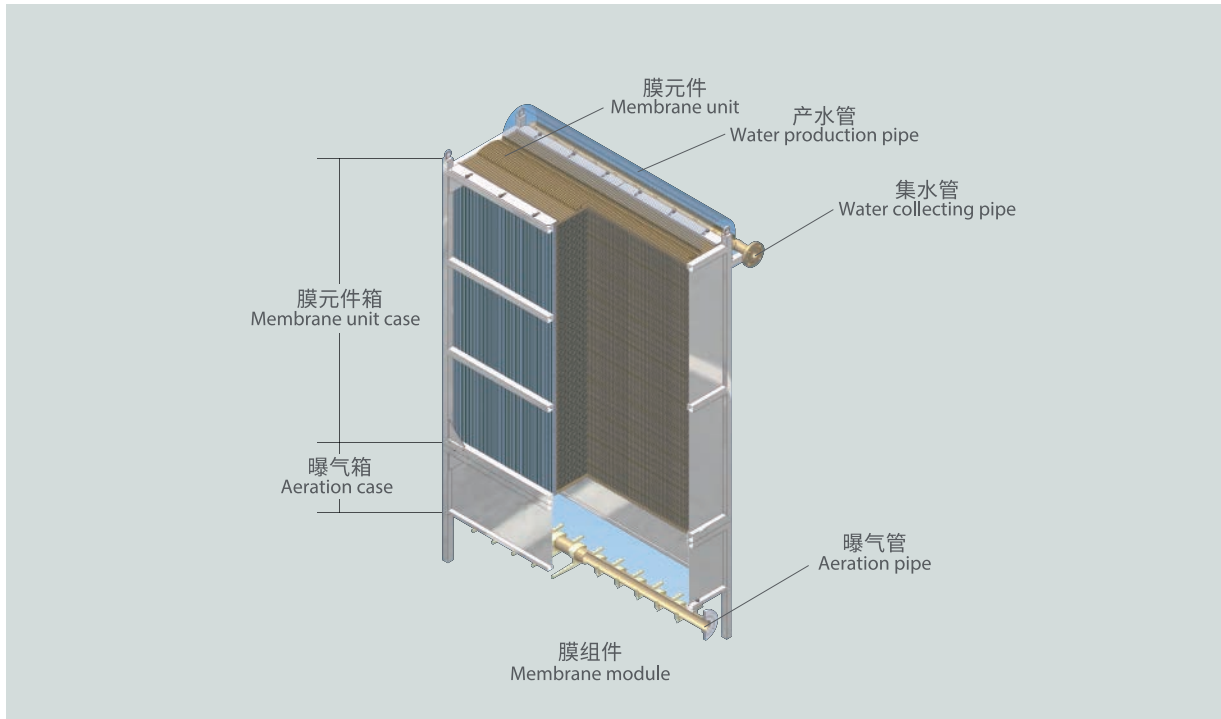

膜组件型号说明 Model Description of Membrane Module

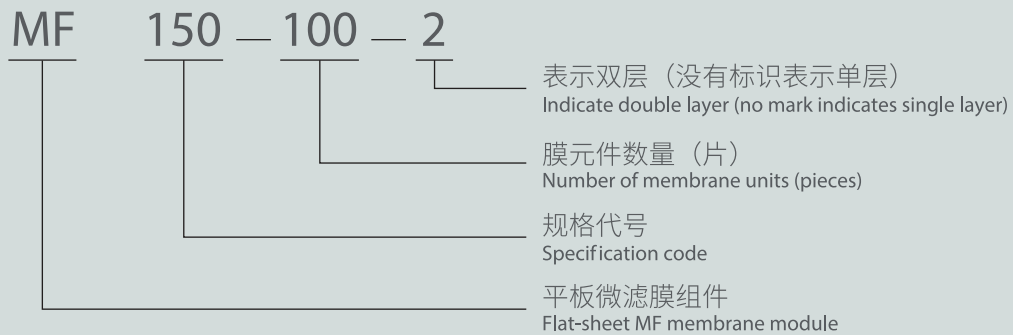

膜组件出水方式 Membrane Module Effluent Mode

MBR 平板膜组件, 分为单出水口膜组件和双出水口膜组件两种类型, 根据膜元件有效膜面积的大小, 单出水口膜组件分为 0.8m²膜组件, 1.0m²膜组件二种型号; 双出水口膜组件仅有 1.5m²膜组件。

MBR flat-sheet membrane modules include two types: single outlet membrane module and double outlet membrane module. Based on the effective membrane area of the membrane unit, single outlet membrane modules have two models (0.8 m² and 1.0 m² membrane modules); double outlet membrane modules have only one model (1.5 m² membrane module).



单出水口膜组件
Single outlet membrane module



双出水口膜组件
Double outlet membrane module

膜组件型号表 Membrane Module Specifications

型号 Model	MF80-100	MF100-100	MF150-100
有效膜面积 (m ²) Effective membrane area (m ²)	80	100	150
尺寸 (mm) (长×宽×高) Dimensions (mm) (length×width×height)	1790×774×1720	1790×802×1880	1790×794×2470
膜元件 (数量) Membrane unit (quantity)	100	100	100
产水量 (m ³ /天) Flux (m ³ /d)	32~48	40~60	69-103.5
重量 (kg) Weight (kg)	420	480	710
支架材质 Frame material	304不锈钢 304 stainless steel		
曝气管材质 Aeration pipe material	ABS和304不锈钢 ABS and 304 stainless steel		
集水管材质 Water collecting pipe material	UPVC 或ABS UPVC or ABS		

注: 1.上表中的产水量均指清水测试值、抽吸负压为-10kPa、温度为25°C时膜的初始过滤通量, 对不同的水质, 其产水量会有较大差别。
2.膜元件的数量可以根据客户要求进行调整, 以10片为单位, 单个膜组件最大装填量为200片。

Note: 1. The Flux in the above table refers to the initial filtration flux (test value of clean water) of the membrane at a negative suction pressure of -10 kPa and water temperature of 25°C, which may differ significantly for different water quality.
2. The number of membrane units can be adjusted according to customer requirements, 10 pieces per unit, with a maximum filling capacity of 200 pieces per membrane module.

膜组件参数与尺寸 Membrane Module Parameters and Dimensions

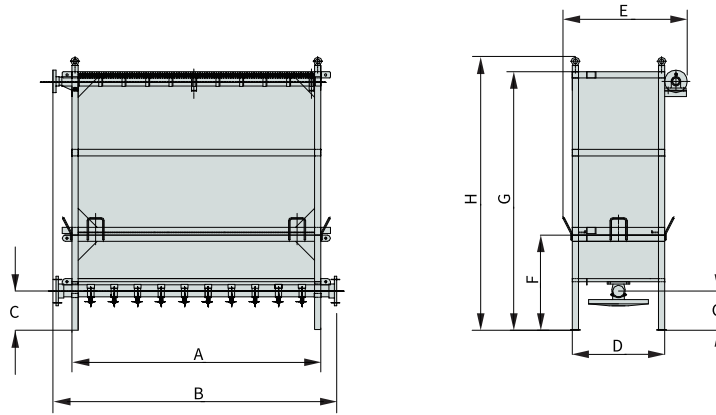

MF80

规格 Specification	有效膜面积 Effective membrane area (m ²)	膜元件数量 Number of membrane units (pieces)	A(mm)	B(mm)	C(mm)	D(mm)	E(mm)	F(mm)	G(mm)	H(mm)
MF80-20	16	20	386	606	248	584	774	600	1630	1720
MF80-30	24	30	534	754						
MF80-40	32	40	682	902						
MF80-50	40	50	830	1050						
MF80-60	48	60	978	1198						
MF80-70	56	70	1126	1346						
MF80-80	64	80	1274	1494						
MF80-90	72	90	1422	1642						
MF80-100	80	100	1570	1790						
MF80-110	88	110	1748	1968						
MF80-120	96	120	1896	2116						
MF80-130	104	130	2044	2264						
MF80-140	112	140	2192	2412						
MF80-150	120	150	2360	2580						
MF80-160	128	160	2508	2728						
MF80-170	136	170	2656	2876						
MF80-180	144	180	2804	3024						
MF80-190	152	190	2952	3172						
MF80-200	160	200	3150	3370						

MF100

规格 Specification	有效膜面积 Effective membrane area (m ²)	膜元件数量 Number of membrane units (pieces)	A(mm)	B(mm)	C(mm)	D(mm)	E(mm)	F(mm)	G(mm)	H(mm)
MF100-20	20	20	386	606	248	612	802	600	1790	1880
MF100-30	30	30	534	754						
MF100-40	40	40	682	902						
MF100-50	50	50	830	1050						
MF100-60	60	60	978	1198						
MF100-70	70	70	1126	1346						
MF100-80	80	80	1274	1494						
MF100-90	90	90	1422	1642						
MF100-100	100	100	1570	1790						
MF100-110	110	110	1748	1968						
MF100-120	120	120	1896	2116						
MF100-130	130	130	2044	2264						
MF100-140	140	140	2192	2412						
MF100-150	150	150	2360	2580						
MF100-160	160	160	2508	2728						

MF100

规格 Specification	有效膜面积 Effective membrane area (m ²)	膜元件数量 Number of membrane units (pieces)	A(mm)	B(mm)	C(mm)	D(mm)	E(mm)	F(mm)	G(mm)	H(mm)
MF100-170	170	170	2656	2876	248	612	802	600	1790	1880
MF100-180	180	180	2804	3024						
MF100-190	190	190	2952	3172						
MF100-200	200	200	3150	3370						

MF150

规格 Specification	有效膜面积 Effective membrane area (m ²)	膜元件数量 Number of membrane units (pieces)	A(mm)	B(mm)	C(mm)	D(mm)	E(mm)	F(mm)	G(mm)	H(mm)
MF150-20	30	20	386	606	248	604	794	600	2380	2470
MF150-30	45	30	534	754						
MF150-40	60	40	682	902						
MF150-50	75	50	830	1050						
MF150-60	90	60	978	1198						
MF150-70	105	70	1126	1346						
MF150-80	120	80	1274	1494						
MF150-90	135	90	1422	1642						
MF150-100	150	100	1570	1790						
MF150-110	165	110	1748	1968						
MF150-120	180	120	1896	2116						
MF150-130	195	130	2044	2264						
MF150-140	210	140	2192	2412						
MF150-150	225	150	2360	2580						
MF150-160	240	160	2508	2728						
MF150-170	255	170	2656	2876						
MF150-180	270	180	2804	3024						
MF150-190	285	190	2952	3172						
MF150-200	300	200	3150	3370						

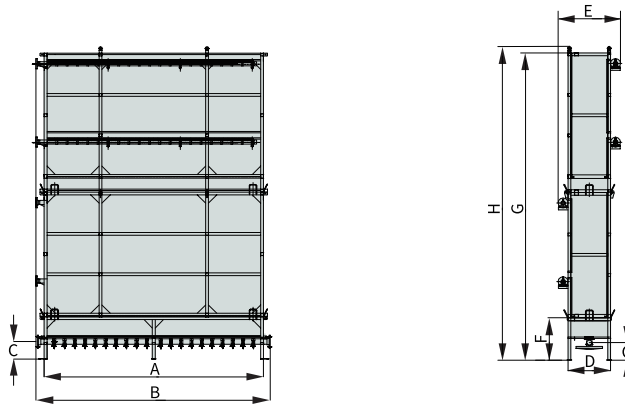

MF150(双层) (Double layer)

规格 Specification	有效膜面积 Effective membrane area (m ²)	膜元件数量 Number of membrane units (pieces)	A(mm)	B(mm)	C(mm)	D(mm)	E(mm)	F(mm)	G(mm)	H(mm)
MF150-100-2(双层)	300	200	1570	1790	248	604	884	600	4360	4450
MF150-150-2(双层)	450	300	2360	2580						
MF150-200-2(双层)	600	400	3150	3370						

注：MF150-100-2(双层)、MF150-150-2(双层)膜组件抽吸管径为DN40；MF150-200-2(双层)膜组件抽吸管径为DN50。

Note: MF150-100-2 (double layer) and MF150-150-2 (double layer) membrane module suction pipe has a diameter of DN40; MF150-200-2 (double layer) membrane module suction pipe has a diameter of DN50.

设计指南

Design Guidelines

预处理 Pretreatment

为了保证膜组件的正常、稳定、长期有效运行，进入系统的原水需满足以下条件：

To ensure the normal, stable, and long-term effective operation of the membrane module, the raw water entering the system shall meet the following conditions:

- 絮凝剂
PAC 和 PAM 应尽量减少进入 MBR 池，过多絮凝剂易造成 MBR 膜污堵。
 - 盐分 (Cl)
被处理水盐分 (Cl) 应小于 4000mg/L，高盐分污水易导致生物死亡，生化系统难以继续进行。
 - 悬浮物
进入 MBR 的原水必须经过 2mm 以下细格栅或 50 目 (0.28mm) 滤网预处理。
 - pH 值
进入膜生物反应池的污水酸碱度应调节在 pH 值 6-9 的范围内。
 - 硬度
当水中硬度较高时 (如钙硬度大于 350 mg/L)，在长期使用过程中，钙盐、镁盐等沉淀性物质会在滤膜和曝气管上沉积结垢，严重影响滤膜及整个 MBR 系统的稳定运行，因此在原水硬度较高时，需要进行预处理。
 - 温度
被处理污水温度一般在 10—40°C 之间，温度过高或过低将影响生物处理效果和滤膜的使用寿命。
 - 油类
浸没式平板 MBR 系统一般情况下不能直接处理高浓度含油废水，油脂类物质会附着在膜表面或堵塞膜孔造成产水量降低，通常要求进入 MBR 池矿物油含量 ≤5mg/L；动植物油含量 ≤20mg/L。
 - 其他物质
进水中不得含有其他影响生化反应及膜分离系统正常运行的有毒有害物质。
-
- Flocculant
The use of PAC and PAM in the MBR tank should be minimized as excessive flocculant may easily cause membrane fouling in MBR.
 - Salinity (Cl)
The salinity (Cl) of treated water should be less than 4,000 mg/L. High-salinity sewage is likely to cause the death of organisms and the unsustainability of the biochemical system.
 - Suspended solids (SS)
The raw water entering the MBR should be pretreated by a fine grid below 2 mm or a 50-mesh (0.28 mm) filter.
 - pH
The pH of sewage entering the MBR should be adjusted to the range of pH 6–9.
 - Hardness
When the water hardness is high (such as calcium hardness greater than 350 mg/L), settleable substances such as calcium salt and magnesium salt will deposit and scale on the filter membrane and aeration pipe during long-term use, which can seriously affect the stable operation of the filter membrane and the whole MBR system. Hence, pretreatment is required when the raw water hardness is high.
 - Temperature
The temperature of treated sewage should generally be 10–40°C. Excessively high/low temperature will affect the biological treatment effect and the service life of the filter membrane.
 - Oils
The submerged flat-sheet MBR system generally cannot treat high-concentration oily wastewater directly as oily substances will adhere to the membrane surface or block the membrane pores, resulting in a decrease in Flux. It is usually required that water entering the MBR tank should have a mineral oil content ≤5 mg/L and animal and vegetable oil content ≤20 mg/L.
 - Other substances
The influent shall not contain other toxic and harmful substances that affect the biochemical reaction and normal operation of the membrane separation system.

膜元件数量计算及设备选型

Calculation of Membrane Unit Quantity and Model Selection

膜元件数量计算

$$\text{膜元件数 } n \text{ (张)} = Q_{\max} \div F \div A \times 1000$$

Q_{\max} : 日最大污水量 (m³/d)

F: 膜通量 (L/m²·d)

生活污水设计膜通量范围: 400~500 L/m²·d

工业废水及特殊废水设计膜通量根据水质进行调整

A: 每张膜片的有效膜面积 (m²/张)

Calculation of membrane unit quantity

$$\text{Number of membrane units (n) (pieces)} = Q_{\max} \div F \div A \times 1000$$

Q_{\max} : maximum daily sewage volume (m³/d)

F: membrane flux (L/m²·d)

Designed flux range for domestic sewage: 400–500 L/m²·d

Designed flux range for industrial and special wastewater is subject to adjustment based on water quality

A: effective membrane area per membrane (m²/piece)

曝气量的设计

$$\text{曝气量: } Q = n \times q \times k$$

n: 膜元件数量, 片

q: 单片膜所需气量, L/min

k: 损失系数, 1.1-1.2

MF80型膜元件, 建议按照每片10L/min设计

MF100建议按照每片11L/min设计

MF150建议按照每片12L/min设计

最大不超过每片14 L/min

Design of aeration volume

$$\text{Aeration volume: } Q = n \times q \times k$$

n: number of membrane units (piece)

q: air volume required per membrane (L/min)

k: loss factor, 1.1–1.2

For MF80 membrane unit, design at 10 L/min per piece is recommended

For MF100 membrane unit, design at 11 L/min per piece is recommended

For MF150 membrane unit, design at 12 L/min per piece is recommended with the maximum of no greater than 14 L/min per piece

抽吸水泵

$$\text{抽吸水泵流量 } Q \geq Q_{\max} \div 24 \div 0.8 \div n \times k$$

Q_{\max} : 日最大污水量 (m³/d)

n: 抽吸水泵数量, 台

k: 损失系数, 1.1-1.2

0.8: 抽8min停2min运行方式, 有效工作时间占比

Suction pump

$$\text{Suction pump flow rate } Q \geq Q_{\max} \div 24 \div 0.8 \div n \times k$$

Q_{\max} : maximum daily sewage volume (m³/d)

n: number of suction pumps (unit)

k: loss factor, 1.1–1.2

0.8: operation mode of suction for 8 min and stop for 2 min, percentage of effective working time

配套产品

MBR系统配套相关设备及产品如表所示

Supporting products

The related supporting equipment and products of the MBR system are shown in the table below.

序号 Serial number	项目 Item	名称 Name
1	曝气相关设备 Aeration related equipment	风机、流量计、阀门 Blowers, flow meters, valves
2	产水相关设备 Effluent related equipment	抽吸泵、液体流量计、负压表 Suction pump, liquid flow meter, negative pressure gauge
3	清洗相关设备 Cleaning related equipment	加药箱、计量泵 Dosing tank, metering pump
4	电控设备 Electric control equipment	PLC、液位控制器 PLC, liquid level controller

池体布置 Tank Layout

为保证良好的曝气流回旋及安装维护的方便，膜池应布置合理，留有足够空间，膜组件的布置参考图 1、图 2 和图 3。

To ensure a good aeration airflow whirling and convenient installation and maintenance, the membrane tank should be reasonably arranged with sufficient space. Refer to Fig. 1, 2 and 3 for the layout of membrane modules.



图1 膜组件间距控制图
Fig. 1 Membrane module spacing control diagram



图2 膜组件边距控制图
Fig. 2 Membrane module space control scheme

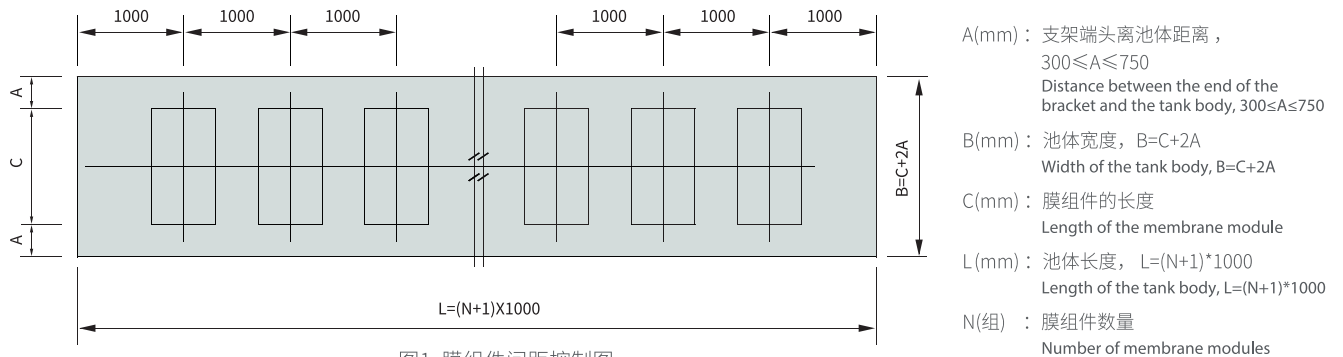

注：膜组件应选用相同型号，在每个膜池或单池每列布置相同数量。

Note: The same model of membrane modules should be selected; the same quantity should be arranged in each membrane tank or each column of a single tank.

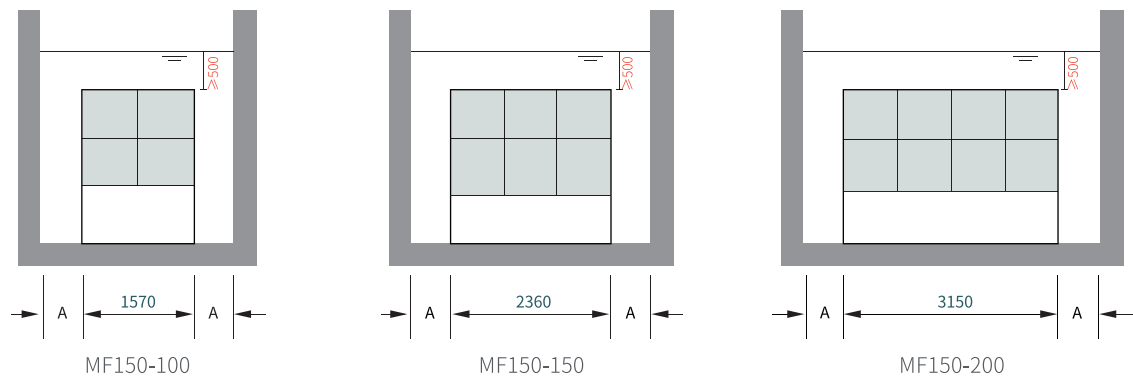
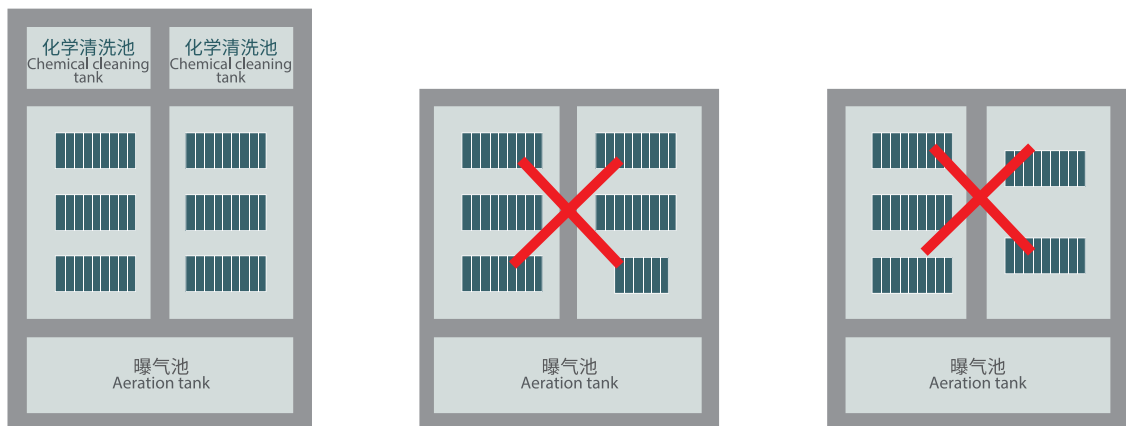
图3 膜组件数量分布图
Fig. 3 Membrane module quantity control scheme

地埋式（紧凑式）布置 Underground (Compact) Layout

通常本公司提供整个膜组件，在组件上已经设置了曝气管，为确保膜组件的正常运行，MBR 池应满足一定的高度。

Generally, our company provides the whole membrane module equipped with the aeration pipe. For the purpose of ensuring the normal operation of the membrane module, the MBR tank should meet certain height requirements.

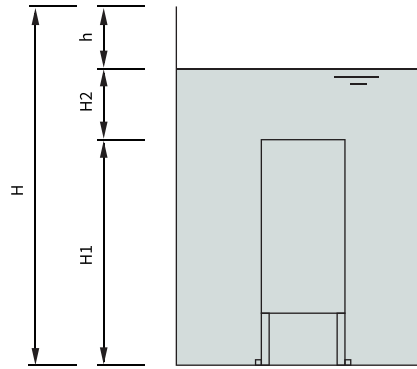

立面尺寸控制图
Facade dimension control scheme

注：1.H：设计池体高度，mm；H1：膜组件高度，mm；H2：安全水深，300~500mm；h：保护高度，300~500mm。
2.地埋式池体或集装箱等局限空间在进行土建及安装时，膜组件正上方预留通道便于膜组件的吊入、安装及维护。

Note: 1. H: designed tank height (mm); H1: membrane module height (mm); H2: safe water depth, 300~500 mm; h: protection height, 300~500mm.
2. During civil construction and installation in confined spaces such as buried tanks or containers, a channel should be reserved directly above the membrane module to facilitate the hoisting, installation, and maintenance of the membrane module.

设计实例

Design Case Study

例：水量： $Q_{max}=400\text{m}^3/\text{d}$ ，水质：生活污水

Example: water volume: $Q_{max} = 400 \text{ m}^3/\text{d}$, water quality: domestic sewage

参数 Parameter	型号 Model	MF80	MF100	MF150	设计说明 Design description
平均通量 (L/m ² ·d) Average flux (L/m ² ·d)		400~500	400~500	400~500	1.适用于生活污水及类似性质的污水 2.工业废水需咨询川源技术人员 1. Suitable for domestic sewage and wastewater of similar nature 2. For industrial wastewater, please consult GSD technicians.
膜元件数量 (片) Number of membrane units (piece)		$400 \div 0.4 \div 0.8=1250$	$400 \div 0.4 \div 1=1000$	$400 \div 0.4 \div 1.5=667$	$n=Q_{max} \div F \div A \times 1000$ Q_{max} : 日处理污水量 (m ³ /d) F: 膜通量 (L/m ² ·d) A: 每张膜片的有效膜面积 (m ² /张) Q_{max} : Daily sewage treatment volume (m ³ /d) F: Membrane flux (L/m ² ·d) A: Effective area per membrane (m ² /piece) Number of membrane modules

参数 Parameter	型号 Model	MF80	MF100	MF150	设计说明 Design description
膜组件数量(片) Number of membrane units (piece)		1250÷160=7.81 选MF80-160膜组件8组 总膜元件数量: 1280片 实际通量: 390 L/m ² ·d Select 8 groups of MF80-160 membrane modules Total number of membrane units: 1,280 pieces Actual flux: 390 L/m ² ·d	1000÷200=5 选MF100-200膜组件5组 总膜片数量: 1000片 实际通量: 400 L/m ² ·d Select 5 groups of MF100-200 membrane modules Total number of membranes: 1,000 pieces Actual flux: 400 L/m ² ·d	667÷170=3.9 选MF150-170膜组件4组 总膜片数量: 680片 实际通量: 392 L/m ² ·d Select 4 groups of MF150-170 membrane modules Total number of membranes: 680 pieces Actual flux: 392 L/m ² ·d	1.每组膜组件最多装200片膜元件 2.膜组件内膜元件以10片加减 1. Each group of membrane modules allows installation of up to 200 membrane units 2. The inner membrane unit of the membrane module is added/reduced by 10 pieces
抽吸泵(m ³ /h) Suction pump (m ³ /h)		Q=400÷24÷0.8×1.2=25	Q=400÷24÷0.8×1.2=25	Q=400÷24÷0.8×1.2=25	抽吸水泵水量Q=Q _{max} ÷24÷0.8÷n×k Q _{max} : 日处理污水量 (m ³ /d) n: 抽吸水泵数量, 台 0.8: 抽8停2 K: 损失系数, 1.1-1.2 Suction pump flow Q = Q _{max} ÷ 24 ÷ 0.8 ÷ n × k Q _{max} : maximum daily sewage volume (m ³ /d) n: number of suction pumps (unit) 0.8: suction for 8 min and stop for 2 min k: loss factor, 1.1-1.2
风机(m ³ /min) Blower (m ³ /min)		Q=1280×10×1.2÷1000 =15.36 风压根据有效水深选定 Wind pressure is selected according to the effective water depth	Q=1000×11×1.2÷1000 =13.2 风压根据有效水深选定 Wind pressure is selected according to the effective water depth	Q=680×12×1.2÷1000 =9.80 风压根据有效水深选定 Wind pressure is selected according to the effective water depth	膜组件所需曝气量: Q=n×q×K n: 膜元件数量, 片 q: 单片膜所需气量, L/min MF80型膜元件, 10L/min设计 MF100型膜元件, 11L/min设计 MF150型膜元件, 12L/min设计 Aeration volume required for membrane module: Q = n × q × k n: number of membrane units (piece) q: air volume required per membrane (L/min) MF80 membrane unit, 10 L/min (design) MF100 membrane unit, 11 L/min (design) MF150 membrane unit, 12 L/min (design)

产品特色

Product Features

快拆式集水管设计 Quick-disconnect water collecting pipe design

传统一体式集水管在安装、拆卸、运输等不同工作环境中可能造成部分损坏, 如要更换耗时、耗力、费用高, 快拆式集水接头, 每十个出水口为一组, 方便快速安装与更换。

The traditional one-piece water collecting pipe may be partially damaged in various working environments such as installation, disassembly, and transportation. It is time-consuming, laborious, and expensive to replace. The quick-disconnect water collecting joint, ten water outlets a group, makes quick installation and replacement convenient.



传统一体式集水管
Traditional one-piece water collecting pipe



快拆式集水管
Quick-disconnect water collecting pipe

ne



欢迎索取以下产品型录



泵系列

潜水泵系列 | 陆上泵系列 | 特种泵系列



搅拌推流系列

搅拌机系列 | 推流器系列



供氧曝气系列

曝气机系列 | 曝气盘系列 | 曝气管系列



风机系列

磁悬浮鼓风机 | 空气悬浮鼓风机 | 三叶罗茨鼓风机系列



污泥处理设备

带式脱水机 | 厢式压滤机 | 叠螺式脱水机 | 污泥干化设备 | 浅层高效气浮设备



智能化系列

智能设备 | 水务设备健康管理 | 水务系统工艺优化智联管理



反应器及套装设备

芬顿反应系统 | MBR膜生物反应器 | 预制泵站 | 一体化污水处理设备



耗材药剂及相关设备

生物绳 | PAC 聚合氯化铝 | PAM 聚丙烯酰胺 | 泡药设备



川源

水处理系统专业合作伙伴

免费咨询电话

400-657-9066

本型录内容如有变更，恕不另行通知。
We reserve the right to change content without notice.

川源(中国)机械有限公司版权所有 all rights reserved. CY-1A

