



川源(中国)机械有限公司  
GSD (China) Co., Ltd.



# LFP

## 低速推流器

**LFP low-speed flow propeller**

# LFP 低速推流器

## LFP low-speed flow propeller



两叶桨  
Two-bladed paddle



三叶桨  
Three-bladed paddle

### 特点 Features

- 高质量国际知名品牌免维护轴承，使用寿命长。
- 独特的电缆密封设计，排除了电缆漏水的隐患。
- 电机轴采用不锈钢材质，转子经动平衡检测，运转平稳。
- 内部设有泄漏传感器和定子绕组超温保护装置
- 低速推流器叶桨由玻璃钢制成，呈后掠式，具有自清洁功能；叶桨光滑的流线型表面，使推力被平均分配。
- 低速推流器所有接触介质的紧固件均采用不锈钢材质；减速装置采用安全系数较高的斜齿轮减速机。

### 用途 Application

低速推流器,在水处理工艺流程中,广泛应用于氧化沟推流,各类生化池的搅拌,同时也可用于河流防冻,景观水循环等。

Low-speed flow propeller extensively used for the oxidizing flow propelling and agitation in various types of biochemical tanks during the water treatment process, also can be used for river frost protection and, landscape water circulation etc.

- The international well-known high-quality bearings have longer service life, which are maintenance free.
- The unique sealing design for the cables removes the hidden danger of water leakage for the cables.
- The shaft of the motor employs the stainless steel, and the rotors are inspected with the use of dynamic balancing, leading to smooth rotation.
- The in-built leakage sensor and the alarming device for the over-temperature protection for the windings of the stator.
- The vanes of the low-speed flow propeller are made of FRP, which are sweptback shape, have the selfcleaning function, the smooth and streamlined propeller surface distributes the propelling power equally.
- On the low-speed flow propeller, all the tightening pieces which will contact media employ the stainless-steel material; The decelerator employs helical gear speed reducer with high safety coefficient.



## 适用条件

- 介质温度：≤40℃
- 介质pH值：5~9
- 介质密度：≤1150kg/m<sup>3</sup>
- 潜水深度：≤20m
- 电源：380V，50Hz
- 电机：F/H绝缘并符合IP68，24小时连续运行

## Conditions of usage

- The highest temperature of the media shall not exceed 40°C
- The pH value of the media: 5~9
- The density of the media shall not exceed 1150kg/m<sup>3</sup>
- The depth of submersion shall not exceed 20m
- The electric power supply: 380V, 50Hz
- The motor: F/H class insulation and in accordance with IP68, continuous operating in 24hr

## 结构简图 Construction

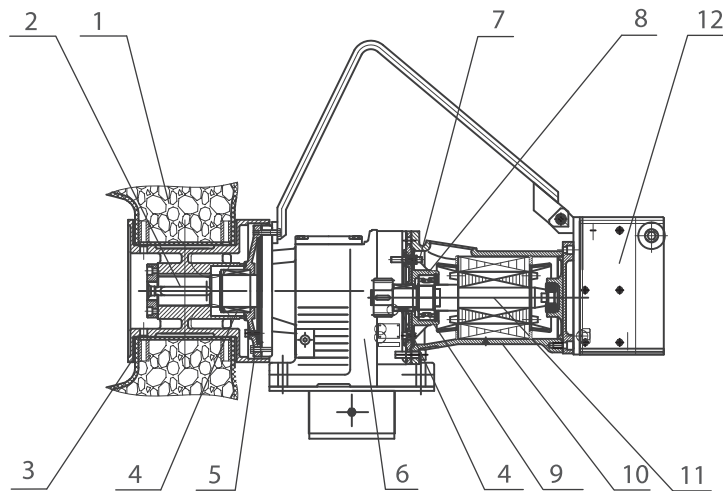

NO.	名称	Name	材质	
			GB	JIS
1	叶桨	Propeller	玻璃钢	FRP
2	输出轴	Output shaft	20Cr13	SUS420J1
3	轮毂	Wheel boss	HT200	FC200
4	机械密封	Mechanical seal	SiC-SiC	SiC-SiC
5	机封座	Mechanical seal stand	HT200	FC200
6	减速机	Decelerator	HT200	FC200
7	泄漏传感器	Leakage sensor	-	-
8	轴承座	Bearing stand	HT200	FC200
9	轴承	Bearing	-	-
10	机壳	Sheath	HT200	FC200
11	电机轴	Motor shaft	20Cr13	SUS420J1
12	滑套	Slide sleeve	HT200	FC200

上表为LFP标配材质，其它材质请另询！不同功率结构略有不同。

The table above is standard material for LFP type. If other material needed, pls contact us. The structure will be different according to the power.

## 型号说明 Type description



## 性能参数 Performance parameters

泵型号 Pump model	电机功率 Motor power (kW)	额定电流 Rated current (A)	叶桨转速 rpm of propeller (r/min)	叶桨直径 Diameter of propeller (mm)	推力 Thrust (N)	重量 Weight (kg)
LFP2.2/4-1100-52/2	2.2	4.9	52	1100	1100	169
LFP3/4-1100-63/2	3	6.6	63	1100	1500	171
LFP4/4-1100-85/2	4	8.6	85	1100	1840	178
LFP2.2/4-1400-34/2	2.2	4.9	34	1400	1430	196
LFP3/4-1400-43/2	3	6.6	43	1400	1870	198
LFP4/4-1400-52/2	4	8.6	52	1400	2150	205
LFP5.5/4-1400-63/2	5.5	11.3	63	1400	2740	208
LFP3/4-1800-34/2	3	6.6	34	1800	2040	205
LFP4/4-1800-43/2	4	8.6	43	1800	2710	212
LFP5.5/4-1800-47/2	5.5	11.3	47	1800	3320	308
LFP7.5/4-1800-52/2	7.5	15.5	52	1800	4010	312
LFP3/4-2100-34/2	3	6.6	34	2100	2150	203
LFP4/4-2100-43/2	4	8.6	43	2100	2600	210
LFP5.5/4-2100-47/2	5.5	11.3	47	2100	3350	306
LFP7.5/4-2100-52/2	7.5	15.5	52	2100	3900	310
LFP3/4-2500-34/2	3	6.6	34	2500	2500	207
LFP4/4-2500-43/2	4	9.3	43	2500	3200	214
LFP5.5/4-2500-39/2	5.5	11.3	39	2500	3200	314
LFP5.5/4-2500-47/2	5.5	12	47	2500	3840	314
LFP7.5/4-2500-43/2	7.5	15.5	43	2500	4030	314
LFP7.5/4-2500-52/2	7.5	15.5	52	2500	4280	314
LFP4/4-1800-34/3	4	9.3	34	1800	2040	222
LFP5.5/4-1800-43/3	5.5	12	43	1800	3320	306
LFP7.5/4-1800-52/3	7.5	15.5	52	1800	4010	310
LFP4/4-2100-34/3	4	8.6	34	2100	2550	219
LFP5.5/4-2100-43/3	5.5	11.3	43	2100	3320	303
LFP7.5/4-2100-47/3	7.5	15.5	47	2100	4030	307
LFP5.5/4-2500-43/3	5.5	12	43	2500	3840	312
LFP7.5/4-2500-47/3	7.5	15.5	47	2500	4280	331

注： 1.电机绕组绝缘等级:F级,防护等级:IP68,电机工作制式:24小时连续工作。

2.可提供H及绝缘电机。

Notes: 1.Winding insulation class of the motor :Class F; Protective grade; IP68; Operating mode: Operation for 24 hours.

2.We can supply the motor with class H winding insulation.



## 流场图 Diagrams of the flow field

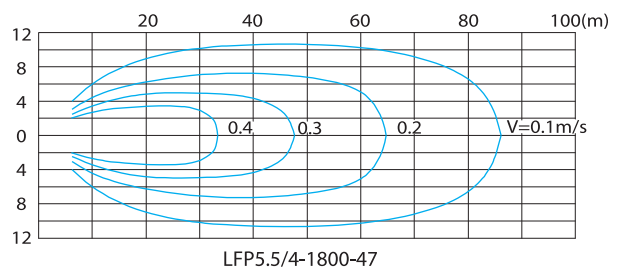
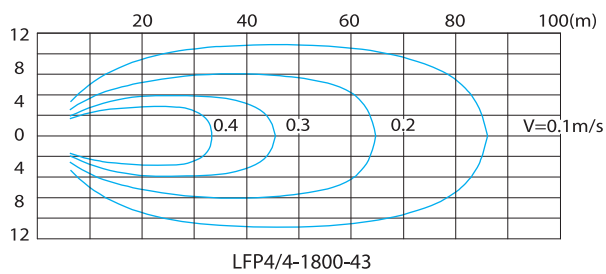
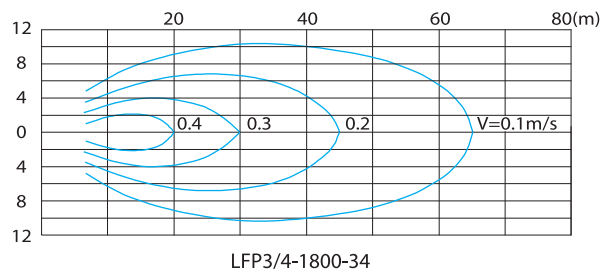
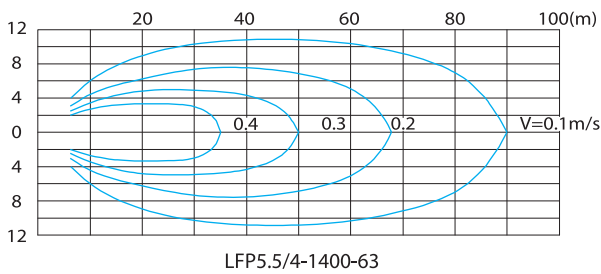
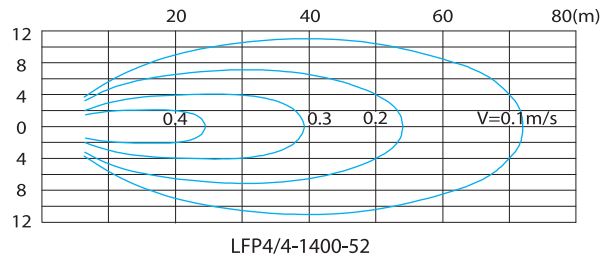
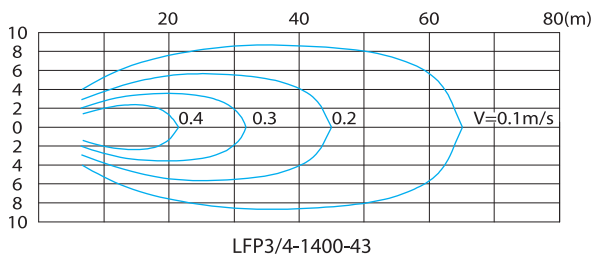
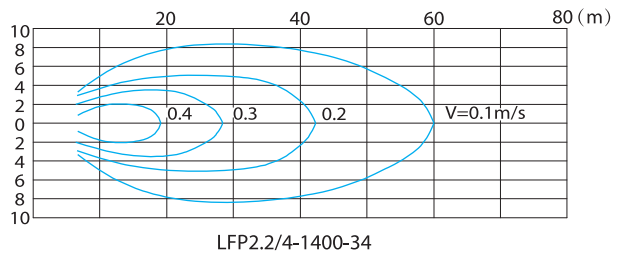
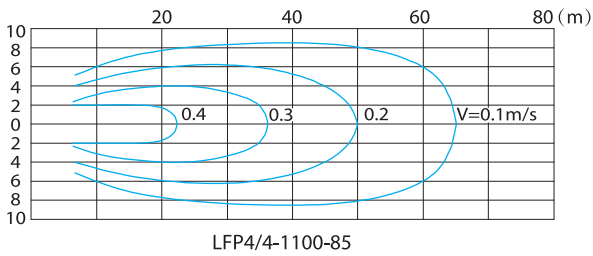
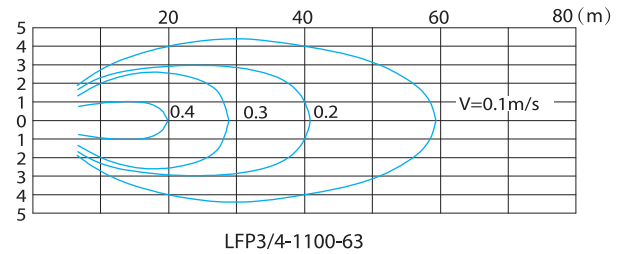
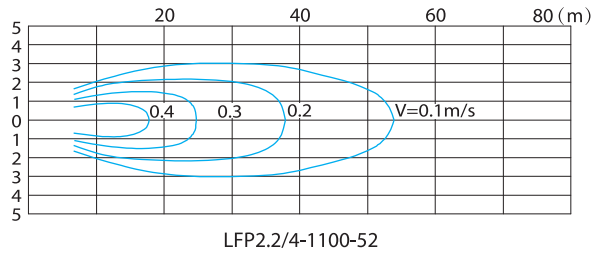

## 流场图 Diagrams of the flow field

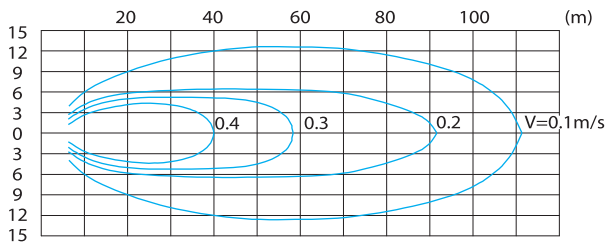

LFP7.5/4-1800-52

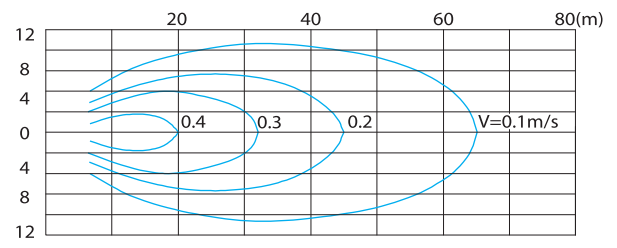

LFP3/4-2100-34

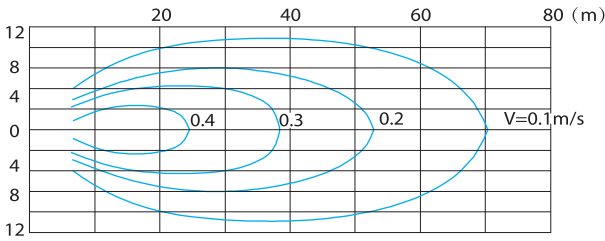

LFP4/4-2100-43

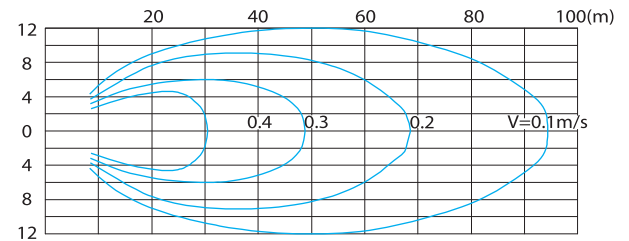

LFP5.5/4-2100-47

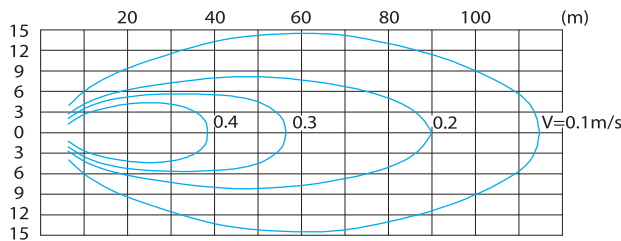

LFP7.5/4-2100-52

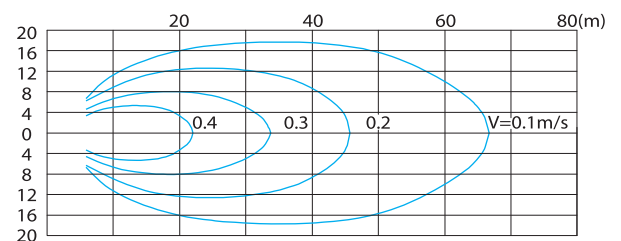

LFP3/4-2500-34

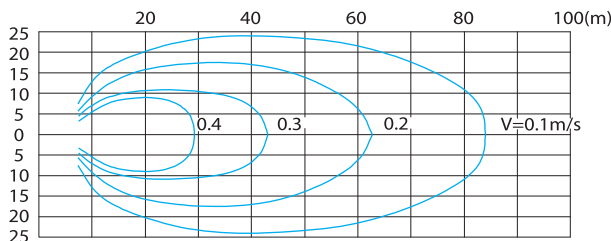

LFP4/4-2500-43

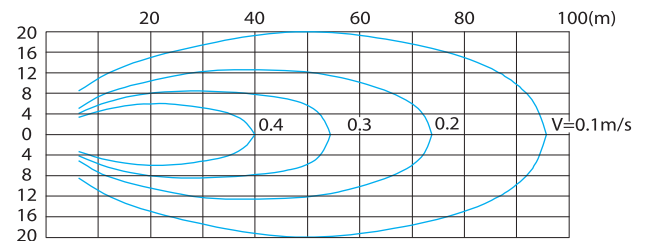

LFP5.5/4-2500-47

LFP5.5/4-2500-39

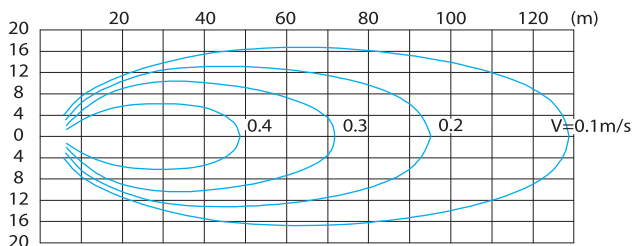

LFP7.5/4-2500-52

LFP7.5/4-2500-43



## 流场图 Diagrams of the flow field

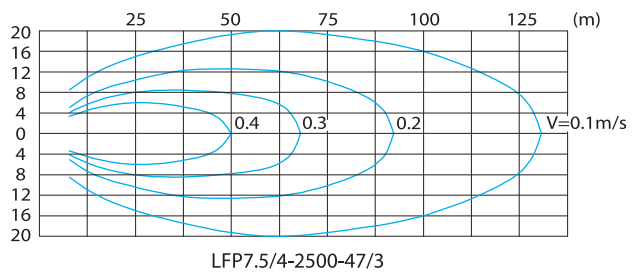
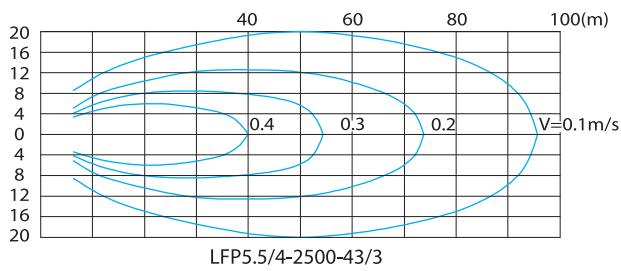
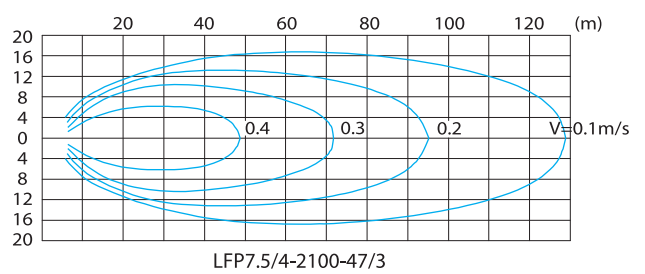
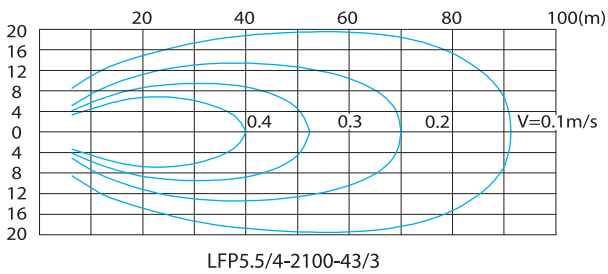
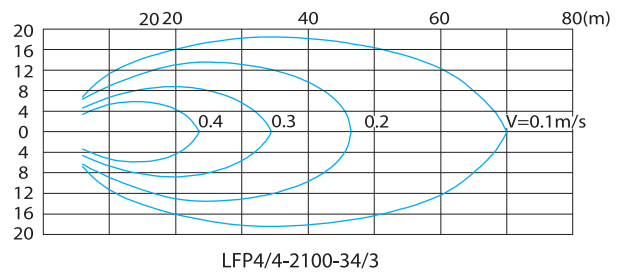
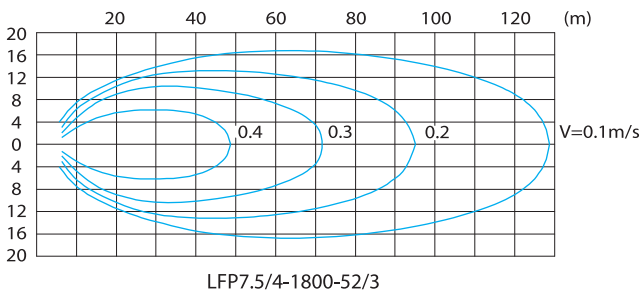
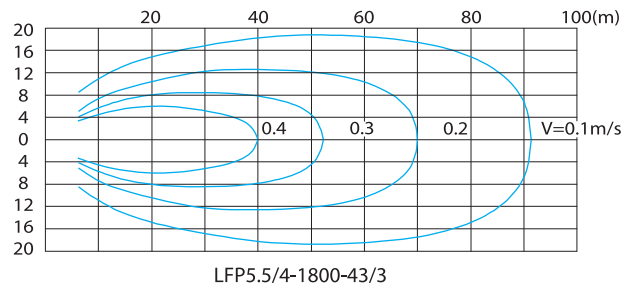
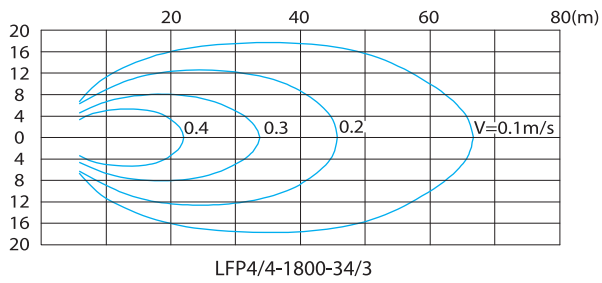

## 安装方式及尺寸

潜水搅拌机可以有多种安装方式, 这里提供最通用的方式供选择, 尺寸可参考下表。我公司还可以根据用户的要求作特殊设计。

## Installation modes and dimensions

The submersible mixers can be installed in a multiple of modes. Here are generally accepted modes of installation for selection with reference made to the following table. Our company can also provide the special designs in accordance with the demand of the users.

型号 Type	a	D	b	L	H <sub>1min</sub>	H <sub>2min</sub>	安装系统 Installation system
LFP2.2/4-1100-52/2	□100	Φ1100	210	1100	1000	270	IV
LFP3/4-1100-63/2	□100	Φ1100	210	1100	1000	270	IV
LFP4/4-1100-85/2	□100	Φ1100	210	1150	1000	270	IV
LFP2.2/4-1400-34/2	□100	Φ1400	210	1100	800	125	IV
LFP3/4-1400-43/2	□100	Φ1400	210	1100	800	125	IV
LFP4/4-1400-52/2	□100	Φ1400	210	1150	800	125	IV
LFP5.5/4-1400-63/2	□100	Φ1400	210	1150	800	125	IV
LFP3/4-1800-34/2	□100/Φ89	Φ1800	210/600	1450/1400	800	125	IV/V
LFP4/4-1800-43/2	□100/Φ89	Φ1800	210/600	1450/1400	800	125	IV/V
LFP5.5/4-1800-47/2	□100/Φ102	Φ1800	200/600	1450/1400	800	125	VI/VII
LFP7.5/4-1800-52/2	□100/Φ102	Φ1800	200/600	1450/1400	800	125	VI/VII
LFP3/4-2100-34/2	□100/Φ89	Φ2100	210/600	1650/1500	900	125	IV/V
LFP4/4-2100-43/2	□100/Φ89	Φ2100	210/600	1650/1500	900	125	IV/V
LFP5.5/4-2100-47/2	□100/Φ102	Φ2100	200/600	1650/1500	900	125	VI/VII
LFP7.5/4-2100-52/2	□100/Φ102	Φ2100	200/600	1650/1500	900	125	VI/VII
LFP3/4-2500-34/2	□100/Φ89	Φ2500	210/600	1650/1500	1000	125	IV/V
LFP4/4-2500-43/2	□100/Φ89	Φ2500	210/600	1650/1500	1000	125	IV/V
LFP5.5/4-2500-39/2	□100/Φ102	Φ2500	200/600	1650/1500	1000	125	VI/VII
LFP5.5/4-2500-47/2	□100/Φ102	Φ2500	200/600	1650/1500	1000	125	VI/VII
LFP7.5/4-2500-43/2	□100/Φ102	Φ2500	200/600	1650/1500	1000	125	VI/VII
LFP7.5/4-2500-52/2	□100/Φ102	Φ2500	200/600	1650/1500	1000	125	VI/VII
LFP4/4-1800-34/3	□100/Φ89	Φ1800	210/600	1450/1400	800	125	IV/V
LFP5.5/4-1800-43/3	□100/Φ102	Φ1800	200/600	1450/1400	800	125	VI/VII
LFP7.5/4-1800-52/3	□100/Φ102	Φ1800	200/600	1450/1400	800	125	VI/VII
LFP4/4-2100-34/3	□100/Φ89	Φ2100	210/600	1650/1500	900	125	IV/V
LFP5.5/4-2100-43/3	□100/Φ102	Φ2100	200/600	1650/1500	900	125	VI/VII
LFP7.5/4-2100-47/3	□100/Φ102	Φ2100	200/600	1650/1500	900	125	VI/VII
LFP5.5/4-2500-43/3	□100/Φ102	Φ2500	200/600	1650/1500	1000	125	VI/VII
LFP7.5/4-2500-47/3	□100/Φ102	Φ2500	200/600	1650/1500	1000	125	VI/VII

注:

- 支撑架和下托架与池壁、池底均可用膨胀螺栓或化学锚栓固定, 对于大直径叶轮和大功率搅拌机最好采用预埋。
- 客户订货时, 请提供池深H及池型图, 以便确定导杆尺寸和支撑架个数。
- 同一种安装系统, 多台搅拌机可共用一套起吊系统。
- 安装系统可选择采用不锈钢或碳钢防腐材质。

Notes:

- The supporting frame and the lower support shall be fixed onto the pond wall and the pond bottom with the use of expansion bolts or chemical anchors. For the big diameter impellers and the big power mixers the best choice is to pre-embed.
- While placing an order by customer. Please supply the pond depth H and the drawing of the pond shape so as to determine the dimensions of the guide rod and the number of the supporting frames.
- A multiple of mixers with the same installation system can share one lifting system.
- The installation systems may employ the material of stainless steel or carbon steel for the selection of the corrosion-resisting properties.





## 外形及安装尺寸 Installation dimensions

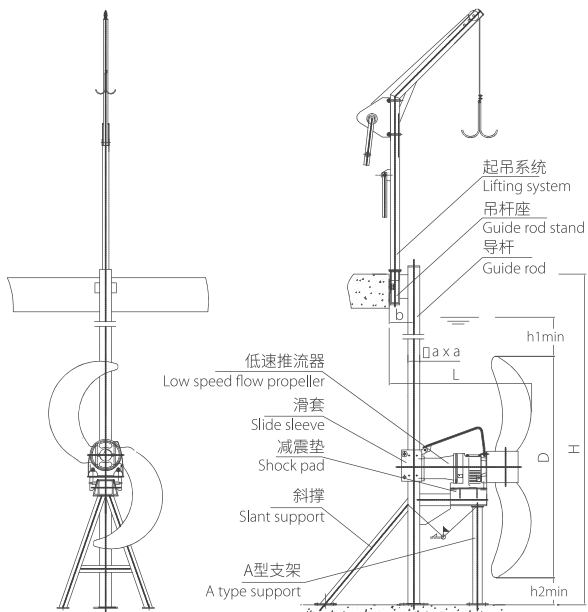

IV 型安装

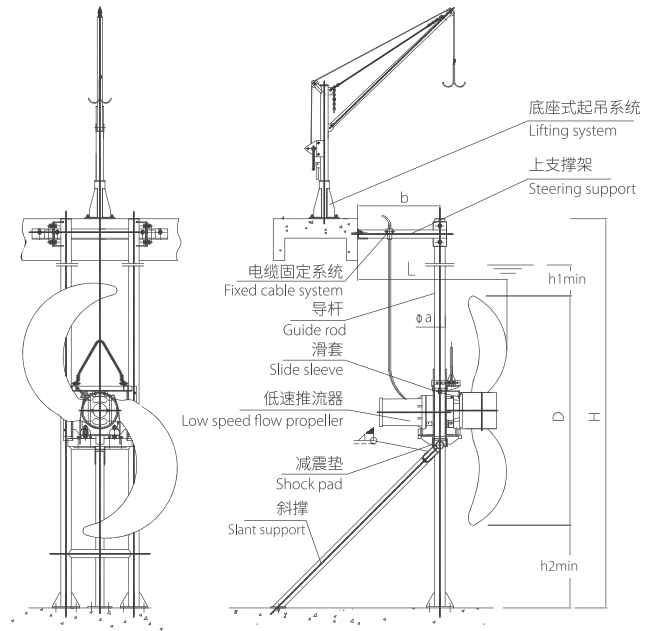

V 型安装

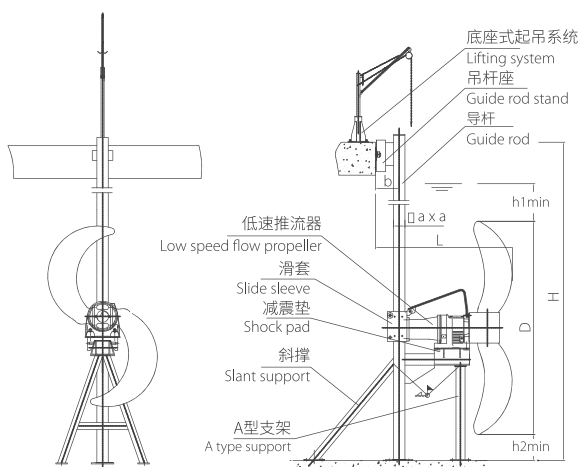

VI 型安装

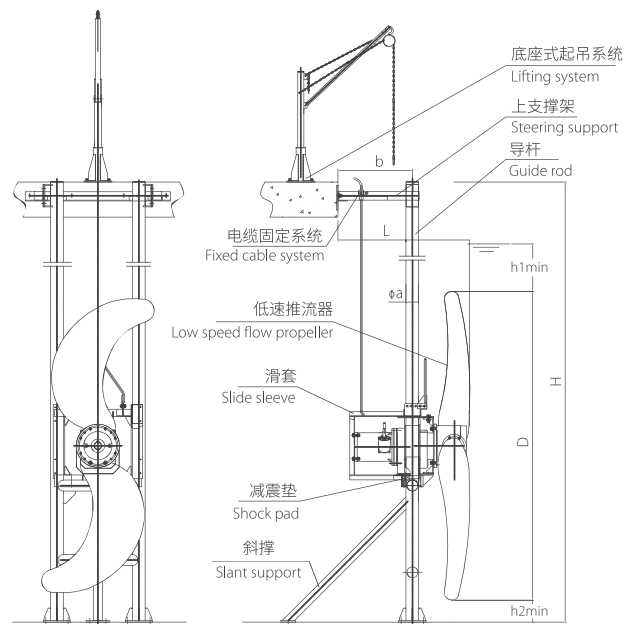

VII 型安装

## 配置示意图

潜水搅拌机的安装定位对其搅拌效果有很大的影响, 为了达到良好的运行效果, 我们建议用户按照专业设计人员的要求去做, 要充分考虑到水池的形状, 进出水的位置以及搅拌机的水流反射到构筑物而引起的涡流等情况, 尽量减少短路循环和死角的生产, 避免与池壁的撞击而降低流速。参照下面的配置示意图, 可帮助您合理选择搅拌机和安装型式。

## Arranging sketch map

The installation and positioning of the submersible mixers will produce a great impact on the effect of mixing. In order to obtain the perfect operating result, it is suggested that the advice of the specialized designers shall be followed and full consideration given to the shape of the pond, position of the water inlet and outlet, the vortex resulting from the outflow from the mixer onto the structures and some other conditions. Every effort shall be made to reduce the short-circuit circulation and the occurrence of dead corners and avoid the dashing of the flow against the pond wall for lowering the flow velocity. Making reference to the arranging sketch map below will help you to make a reasonable selection of the mixers and their installation modes.

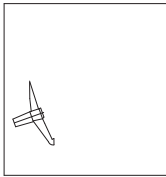

方形池 Square pond

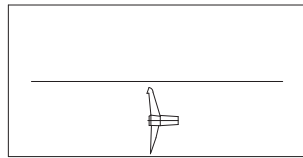

矩形池 Rectangular pond

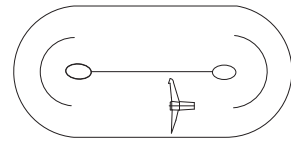

跑道形池 Track-shaped pond

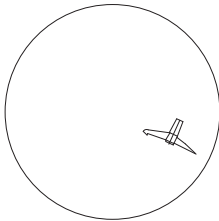

圆形池 Circular pond

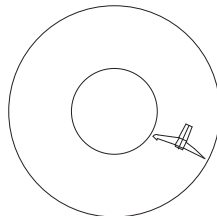

环形池 Ring-shaped pond

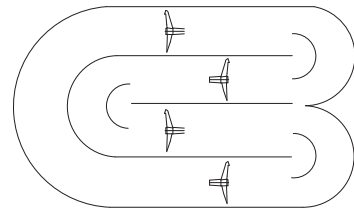







S曲线形池 S-shaped pond

如蒙洽询请指示下列各项  
For further details, please fulfill the chart below.

客户 \_\_\_\_\_ 承办人员 \_\_\_\_\_  
Customer \_\_\_\_\_ Undertaker \_\_\_\_\_

工程名称 \_\_\_\_\_ 工程地点 \_\_\_\_\_  
Name of project \_\_\_\_\_ Address of project \_\_\_\_\_

电话 \_\_\_\_\_ 传真 \_\_\_\_\_  
Telephone \_\_\_\_\_ Fax \_\_\_\_\_

基本选型参数 Basic parameters	*工艺名称 Processes name	氧化沟 Oxidation ditch	<input type="checkbox"/>	A-O法 A-O	<input type="checkbox"/>	SBR法 SBR	<input type="checkbox"/>	其它(注) Others		
	*安装位置 Installation location							其它(注) Others		
	*基本池型(m) Pond form	长 L	宽 W	深 H	长 L	宽 W	深 H	长 L	宽 W	深 H
	*有效水深(m) Available water depth									
介质参数 Media parameter	介质名称 Name						密度 Density			
	主要成分 Main composition						* PH 值 PH			
	* 温度 Temperature						黏度 Viscosity			
	其它 Other									
工艺要求参数 Technique parameters	*主要搅拌混合方式 Mixing methods	搅拌型 Mixing agitator	<input type="checkbox"/>	推流型 Flow propeller	<input type="checkbox"/>	其它(注) Other				
	*池底最低流速(m/s) Minimum flow speed at the bottom									
	其它工艺要求 Other requests									
池形结构 Pool structure	*池沿结构 Pool surface structure		<input type="checkbox"/>		<input type="checkbox"/>		<input type="checkbox"/>	其它 Others	<input type="checkbox"/>	
	*池底结构 Pool bottom structure		<input type="checkbox"/>		<input type="checkbox"/>		<input type="checkbox"/>	其它 Others	<input type="checkbox"/>	
材质要求 Material requests	主机壳体 Shell body						* 水下导杆及支座 Guide and support			
	搅拌叶桨 Mixing propeller						* 水上吊架及支座 Hanger and support			
	导流罩(是否需要) Fairwater(need or not)						* 螺栓、螺母及垫圈 Bolt, nut and gasket			
	主轴 Main shaft						* 提升钢丝绳 Boom hoist cable			
搅拌机结构性能参数 The machine parameters	传动方式 Driving method						电机功率(kW) Motor power			
	密封形式 Seal type						额定电流(A) Rated current			
	叶轮直径(mm) Propeller diameter						电源 Power			
	叶轮转速(rpm) Propeller speed						防护等级 Protection grade			
	推力(N) Thrust						工作制式 Working standard			
其它要求 Others										

注:为准确选型,项目前加注“\*”号者,请务必详加填写。

Note:In order to choose the right type, the item with “\*” should be filled as detail as possible.

欢迎索取以下产品型录



### 泵系列

潜水泵系列 | 陆上泵系列 | 特种泵系列



### 搅拌推流系列

搅拌机系列 | 推流器系列



### 供氧曝气系列

曝气机系列 | 曝气盘系列 | 曝气管系列



### 风机系列

磁悬浮鼓风机 | 空气悬浮鼓风机 | 三叶罗茨鼓风机系列



### 污泥处理设备

带式脱水机 | 厢式压滤机 | 叠螺式脱水机 | 污泥干化设备 | 浅层高效气浮设备



### 智能化系列

智能设备 | 水务设备健康管理 | 水务系统工艺优化智联管理



### 反应器及套装设备

芬顿反应系统 | MBR生物膜反应器 | 预制泵站 | 一体化污水处理设备



### 耗材药剂及相关设备

生物绳 | PAC 聚合氯化铝 | PAM 聚丙烯酰胺 | 泡药设备

## GSD 的经营理念

**G-Green 绿色** **S-Safe 安全** **D-Development 永续经营**



# 川源

## 水处理系统专业合作伙伴

免费咨询电话

**400-657-9066**

数据来源：公司实验室数据及客户实际使用数据，具体使用环境不同，数据可能存在差异。

The data on the brochure is based on the laboratory testing data and customers' actual operation data in the past. The actual data may be different in different application conditions.

本型录内容如有变更，恕不另行通知。

We reserve the right to change content without notice.

川源（中国）机械有限公司版权所有 all rights reserved. CY-31

