



川源(中国)机械有限公司
GSD (China) Co., Ltd.



SQW

沉水式污物(泥)泵

SQW submersible solid handling pump

SQW 沉水式污物(泥)泵

SQW submersible solid handling pump



用途 Application

- 废水扬升站
 - 都市废水处理厂
 - 一楼化粪池排水系统
 - 医院、学校、社区等生活废水处理系统
 - 食品、造纸、采矿、纺织、皮革、化工厂等工业之废水处理系统
 - 净水处理系统
-
- Wastewater lift station.
 - Municipal wastewater treatment plant.
 - Building wastewater treatment system.
 - Hospital, school, community, etc. wastewater treatment system.
 - Food, paper, mining, textile, leather, chemical industry, etc. wastewater treatment system.
 - Water purification system.

特点 Features

- **电动机**
鼠笼式感应电动机，F级绝缘，防护等级IP68。
 - **叶轮**
采用CFD技术设计，宽出水口，水流畅通，污物容易通过，效率高。
所有叶轮均经动、静平衡校正，能够减少振动和噪音，运转平稳，寿命长。
 - **机械密封**
机械密封的作用是阻绝抽送介质与电动机部分接触，双机械密封串联相互独立工作，为电动机提供双重保护。
 - **自动着脱装置（选用配备）**
使泵浦安装、保养、修护迅速容易，毋须先清除桶槽污水。
 - **测漏检知器（选用配备）**
在油室内加装测漏检知器，可检测因密封不良或机械密封损坏造成之洩漏。
 - **过热保护器（选用配备）**
在电动机中加装过热保护器，对过载、温升等状况自动进行检测，避免由于电动机过热造成电机烧毁。
-
- **Motor**
Squirrel-cage, induction motors are F class insulation, motor protection grade is IP68.
 - **Impeller**
The pump uses CFD technique for design, with wide inlet, which makes the stable flow, easier sewage passage and high efficiency. It adopts rigorous technics so that vibration and noise can be farthest reduced.
 - **Mechanical seal**
The mechanical seals protect the motor from contacting the pumping liquids. Two seals are in series with each other and individually work to provide the motor with a dual protection.
 - **Auto-setter (options)**
To allow pump for easy installation, maintenance & reparation, as it is no need to empty the tank first.
 - **Leakage detector (options)**
Built-in leakage detector in the oil chamber can detect leakage from the damage of the mechanical seal.
 - **Heat-protector (options)**
Built-in heat protector in motor, can prevent the motor from burning out, overload & overheating.



型号说明 Type description

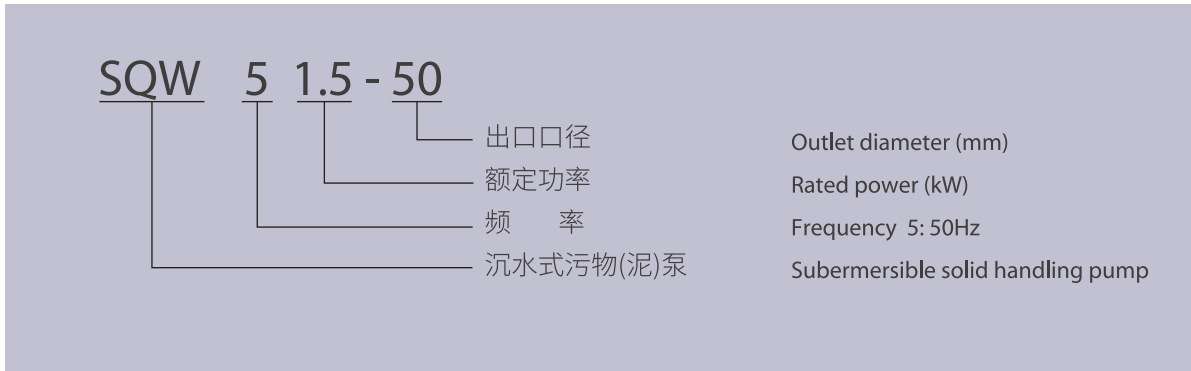

结构简图 Construction

NO.	名称	Name	材质	
			GB	JIS
1	动力电缆	Power cable	NBR	NBR
2	电缆压盖	Cable cover	06Cr19Ni10	SUS304
3	波形弹簧	Wave spring	65Mn	65Mn
4	电木板	Electric board	-	-
5	马达本体	Motor casing	HT200	FC200
6	挡圈	Retaining ring	65Mn	65Mn
7	中承座	Bracket	HT200	FC200
8	O型圈	O-ring	NBR	NBR
9	油箱盖	Oil cover	HT200	FC200
10	叶轮	Impeller	HT200	FC200
11	泵体	Pump casing	HT200	FC200
12	垫圈	Washer	20Cr13	SUS420J1
13	螺栓	Bolt	06Cr19Ni10	SUS304
14	密封环	Seal ring	ZCuSn10Pb5	LBC2
15	把手	Handle	06Cr19Ni10	SUS304
16	马达盖	Motor cover	HT200	FC200
17	轴承	Bearing	-	-
18	转子	Rotor	-	-
19	定子	Stator	-	-
20	主轴	Shaft	20Cr13	SUS420J1
21	机械密封	Mechanical seal	C-SiC	C-SiC
22	机械密封	Mechanical seal	SiC-SiC	SiC-SiC
23	键	Key	20Cr13	SUS420J1
24	固定架	Fixed frame	Q235A	SS400
25	引导管	Pail piping	06Cr19Ni10	SUS304
26	配合凸缘	Flange setter	HT200	FC200
27	着脱本体	Duckfoot	HT200	FC200

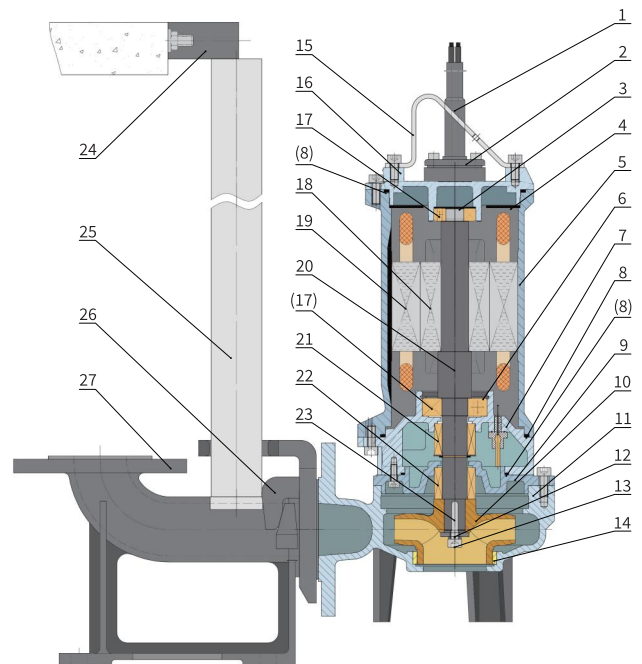

不同机型结构略有不同，可根据需求采用不同材质。
 Different model has a little difference,
 Materials can be selected according to the requirement of the customer.

型谱图 Performance chart

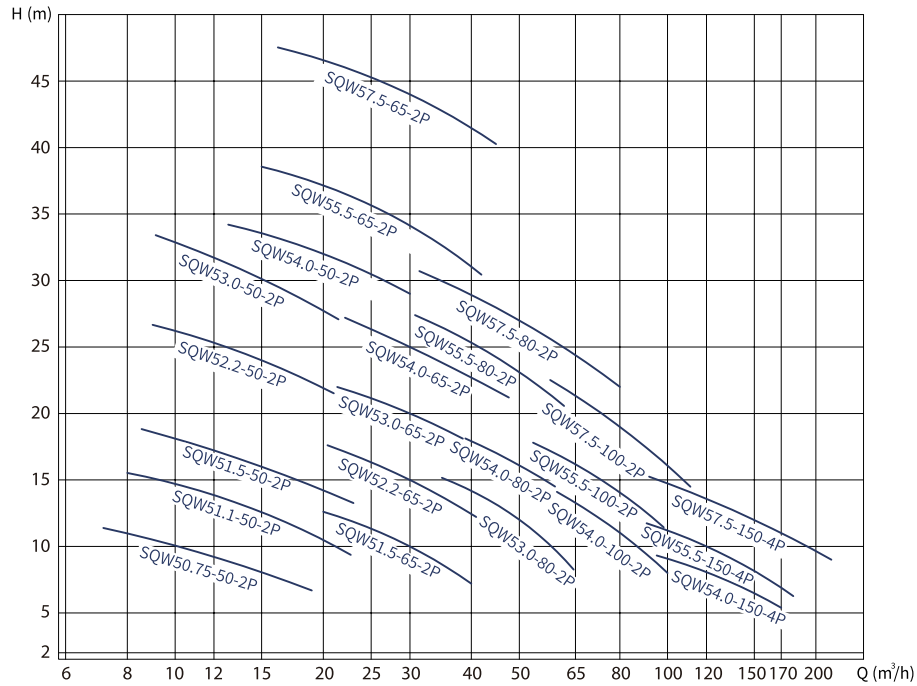

性能参数 Performance parameters

(2P/4P)

泵型号 Pump model	行业型号 Industry model	转速 Speed (r/min)	流量 Capacity (m ³ /h)	扬程 Head (m)	效率 Eff. η (%)	电机功率 Motor power (kW)	口径 Dia. (mm)	泵重量 Weight (kg)
SQW50.75-50-2P	50QW15-8-0.75	2840	15	8	58	0.75	50	23
SQW51.1-50-2P	50QW15-12.5-1.1	2840	15	12.5	60	1.1	50	27
SQW51.5-50-2P	50QW15-16-1.5	2840	15	16	55	1.5	50	34
SQW52.2-50-2P	50QW15-24-2.2	2840	15	24	54	2.2	50	38
SQW53.0-50-2P	50QW15-30-3.0	2840	15	30	54	3.0	50	44
SQW54.0-50-2P	50QW20-32-4.0	2840	20	32	56	4.0	50	50
SQW51.5-65-2P	65QW30-10-1.5	2840	30	10	62	1.5	65	32
SQW52.2-65-2P	65QW30-15-2.2	2840	30	15	64	2.2	65	36
SQW53.0-65-2P	65QW30-20-3.0	2840	30	20	60	3.0	65	44
SQW54.0-65-2P	65QW30-25-4.0	2840	30	25	62	4.0	65	50
SQW55.5-65-2P	65QW30-34-5.5	2840	30	34	58	5.5	65	65
SQW57.5-65-2P	65QW30-44-7.5	2840	30	44	58	7.5	65	73
SQW53.0-80-2P	80QW50-12-3.0	2840	50	12	65	3.0	80	47
SQW54.0-80-2P	80QW50-16-4.0	2840	50	16	67	4.0	80	53
SQW55.5-80-2P	80QW50-23-5.5	2840	50	23	63	5.5	80	64
SQW57.5-80-2P	80QW50-27-7.50	2840	50	27	66	7.5	80	72
SQW54.0-100-2P	100QW80-11-4.0	2840	80	11	67	4.0	100	58
SQW55.5-100-2P	100QW80-14-5.5	2840	80	14	68	5.5	100	68
SQW57.5-100-2P	100QW80-19-7.5	2840	80	19	69	7.5	100	75
SQW54.0-150-4P	150QW120-8-4.0	1450	120	8	72	4.0	150	93
SQW55.5-150-4P	150QW120-10-5.5	1450	120	10	73	5.5	150	114
SQW57.5-150-4P	150QW120-12-7.5	1450	150	12	74	7.5	150	124



安装示意图 Installation sketch map

未附着脱
without autosetter











附着脱
with autosetter



欢迎索取以下产品型录

To find out more about following products, please visit www.gsd.net.cn

	泵系列 Pump Series	潜水泵系列 陆上泵系列 特种泵系列 Submersible pump series On land pump series Special pump series
	搅拌推流系列 Mixing and flow propeller	搅拌机系列 推流器系列 Mixing series Flow propeller series
	供氧曝气系列 Aeration equipment series	曝气机系列 曝气盘系列 曝气管系列 Aerator series Disc diffusers Tube diffusers
	风机系列 Blower Series	磁悬浮鼓风机 空气悬浮鼓风机 三叶罗茨鼓风机系列 Maglev turbo blower Turbo blower Three-lobe roots blower series
	污泥处理设备 Sludge treatment equipment	带式脱水机 厢式压滤机 叠螺式脱水机 污泥干化设备 浅层高效气浮设备 Belt filter press Box filter press Screw press Mud scraper Dissolved air flotation clarifier
	智能化系列 Intelligent series	智能设备 水务设备健康管理 水务系统工艺优化智联管理 Intelligent equipment Health management for water equipment Intelligent management for water system process
	反应器及套装设备 Reactor and package equipment	芬顿反应系统 MBR生物膜反应器 预制泵站 一体化污水处理设备 Fenton reaction system MBR biofilm reactor Prefabricated pumping station Intelligent Compact Unit
	耗材药剂及相关设备 Consumables, reagents and related equipment	生物绳 PAC 聚合氯化铝 PAM 聚丙烯酰胺 泡药设备 Biological rope PAC polyaluminum chloride PAM polyacrylamide Automatic dispensing dissolvers

GSD的经营理念 Business Philosophy

G-Green 绿色 S-Safe 安全 D-Development 永续经营



川源(中国)机械有限公司
GSD (China) Co., Ltd.

水处理系统专业合作伙伴

Professional partners in water treatment systems

免费咨询电话

400-657-9066

川源(中国)机械有限公司版权所有 all rights reserved. CY-3B

数据来源: 公司实验室数据及客户实际使用数据, 具体使用环境不同, 数据可能存在差异。本型录内容如有变更, 恕不另行通知。

The data on the brochure is based on the laboratory testing data and customers' actual operation data in the past. The actual data may be different in different application conditions. We reserve the right to change content without notice.

